

T: 828-735-1978; F: 866-340-1699; E: SALES@JXTCOMPANY.COM



Weatherseal Applications



Contents

About Sealeze	2
Help and How to Order	2
Why Brush Weatherseal is Better	3
Brush Weatherseals for	
Entrance Doors	4
Door Sweeps	5
Door Sweep Kits	5
How to Select the Right	5
Jamb Seals	6
Jamb Seal Kits	6
Selecting the Right Door Jamb	6
Astragal Seals	7
Astragal Kits	7
AstraSweep Kits	7
Seals for Overhead Doors	8
Light Duty Brush Seals	9
Standard Duty Brush Seals	9
Heavy Duty Brush Seals	10
Plastic Guide Seals	12
Reverse Angle Clip-On	12
Garage Door Threshold	12
Adjustable Door	
Bottom Seal	12
ProSeal	13
Dock Leveler Applications	14
Dock Leveler Seals	14
Weldable Dock	
Leveler Seals	14
Hinge Seals	14
Flexible Strip Brush	15
Installation Instructions for Metal-Backed brush & Aluminum Holders	15
Terms and Conditions	15





Help and How to Order

General Ordering

The following information for each part number will be needed when placing your order:

1. Part number, including brush length.
2. Whether or not slots and screws are required.
3. Length of the part in feet and inches.
4. Number of pieces.

Contact Us

For immediate answers and free samples*:

• Call: 828-735-1978

• Fax: 866-340-1699

• Visit: www.jxtcompany.com

• Email: sales@jxtcompany.com

Therm-L-Brush® is made from 100% type-6 black nylon filament. Proseal is made of polypropylene filament. Our aluminum extrusions are stocked in the following finishes: CLA (clear satin anodized), DUR (duranodic), and GLD (polished brass anodized).

Order YOUR way to promote easy installations:

- **Stocked Length:** Therm-L-Brush and all Sealeze products are available directly from stock for immediate shipment in stocked lengths. Current stock lengths are 3, 7, 8 and 10 feet. (Length availability varies by products.)
- **Custom Cut-To-Length:** We will custom cut our weatherseals to the lengths you need—usually at no additional charge. Contact your sales representative with your requirements.
- **Stocked Kits:** Therm-L-Brush for entrance doors and residential garage doors is stocked in kit form in selected part numbers. Kits are poly-bagged and include the following:
 - Pre-cut weatherseals
 - Slotted holder flanges for adjustable installation
 - Self-drilling screws for fast installation
 - Instructions

Contact your sales representative for availability.

- **Custom Kits:** If you need custom door kits for non-standard size doors, call your sales representative with your requirements. We'll work with you!
- **Shipping†:** Small orders of lengths 8 feet and under are shipped UPS unless specified otherwise. Orders with lengths over 8 feet must go by truck. To save minimum freight charges on small orders, consider having lengths longer than 8 feet cut in half or some other combination in order to save on freight costs by shipping UPS.

For questions and assistance, please call your sales representative for expert advice!

* A 4 inch sample of a brush and holder will be sent to you following a discussion with a Sealeze sales representative regarding your application requirements.

† Therm-L-Brush is shipped with slots and self-drilling TEK screws with Phillips/hex drive slots. UL Labels are applied upon request.

Why Brush Weatherseal is Better

Doors are installed to close an opening, to keep inside air in and outside air out. However, for proper operation, doors need clearance. This clearance creates a gap that allows air infiltration. Installing Therm-L-Brush® Weatherseal is the most effective means to prevent air infiltration, thus saving money on heating and cooling costs.



Color of holders shown are approximate.

Why Sealeze Brush Weatherseal?

A 1/8 inch gap around a standard 3 x 7 foot entrance door is equivalent to a hole with an area of 30 square inches. Sounds drafty, doesn't it? Therm-L-Brush will put an end to that draft!

A 1/4 inch gap on the sides and top of a 10 x 10 foot sectional door is equivalent to a hole with the area of 90 square inches. Imagine what else could be coming in with the wind! Therm-L-Brush Weatherseals prevents unwanted pests.

An unsealed 10 x 10 foot sectional door can permit 328 million cubic feet of air infiltration in a year. Think of all the money being spent on heating and cooling costs. Therm-L-Brush Weatherseals will more than pay for itself.

Why prevent air infiltration?

Air infiltration means that outside air is displacing inside air. And every cubic foot of infiltrated air will be heated or cooled at someone's expense. With air infiltration comes a host of unwanted elements including dust, sand, rain and snow, noise and fumes, birds, bats, insects and rodents. Effective weather sealing with brush keeps all of these outside where they belong and helps reduce heating and cooling costs.

Why use Therm-L-Brush Weatherseal?

It is simply the best weatherseal, effectively blocking 98.5% of air infiltration. It is at least three times more effective than vinyl, and rarely needs to be replaced. Therm-L-Brush will not interfere with the operation of the door. A study by the U.S. Navy on energy conservation found Therm-L-Brush to be the superior weatherseal material.

How does it work?

Therm-L-Brush is a dense wall of nylon filaments bound securely by a strip of galvanized steel and held in an aluminum holder. This wall of nylon forms an almost air-tight barrier. It is flexible, allowing unimpeded door movement. It will not tear or pull out and conforms to surface irregularities maintaining a complete weather tight seal for the life of the door.

It's better.

Therm-L-Brush lasts longer and seals better than vinyl, felt, neoprene, silicone, or any other weatherstrip product.

It's easy to install.

Therm-L-Brush aluminum holders come slotted with self-drilling TEK-type screws for quick, low-cost installation. When using double backed tape, installation takes seconds.

It's attractive.

Therm-L-Brush comes in a variety of holder and brush color combinations that complement any door. The aluminum holders are available in a clear anodized finish, a gold anodized finish, or a dark brown duranodic finish. Brush filaments are stocked in black.

It's UL 3-Hour Fire Door rated.

Sealeze Nylon Therm-L-Brush up to 4 inches long are UL labeled upon request) for use on 3-hour fire doors.

It lasts the longest.

Independent laboratory testing has proven our brush to stand up to 2,000,000 cycles (opening and closing) without degradation. Nylon filaments give Therm-L-Brush unmatched flexibility and durability. Not only does it conform to all surface contours for a complete seal but, it won't tear like solid sealing materials can. Therm-L-Brush can last the life of the door, rarely needing to be replaced. The nylon holds up to the weather like nothing else. Installations of 10-15 years are the rule, not the exception.

It works in extreme temperatures. even at 70° below.

In the coldest climates, where vinyl and other materials can freeze and become brittle, Sealeze Therm-L-Brush will stay flexible.

It blocks light.

It's ideal for sealing doors to light-sensitive areas and for use around warehouses and food preparation areas to keep out pests. With no light visible, there is less of a chance of attracting pests.

It blocks sound.

Independent laboratory tests shows Sealeze Therm-L-Brush effectively reduces sounds that can come through the openings around interior and exterior doorways.

Brush Weatherseal for Entrance Doors

The importance of sealing openings in a building applies to entrance doors just as it does to overhead doors. Any gap around a door causes energy loss due to air infiltration. Dirt and debris are just as much of a problem. Brush designed as Door Bottom Seals and Door Jamb Seals provide the most effective means of solving these problems. Mounted

using special finished holders, brush weatherseals provide an attractive and effective solution to gaps for any door. And, Sealeze AstraSweep® corner seals when used with Sealeze door sweeps and astragal seals, provide a more complete seal by closing the gap between the sweep and astragal.

Keeps out: drafts, light, insects, noise, dust, sand, wind, rain, snow, sleet, fumes and rodents

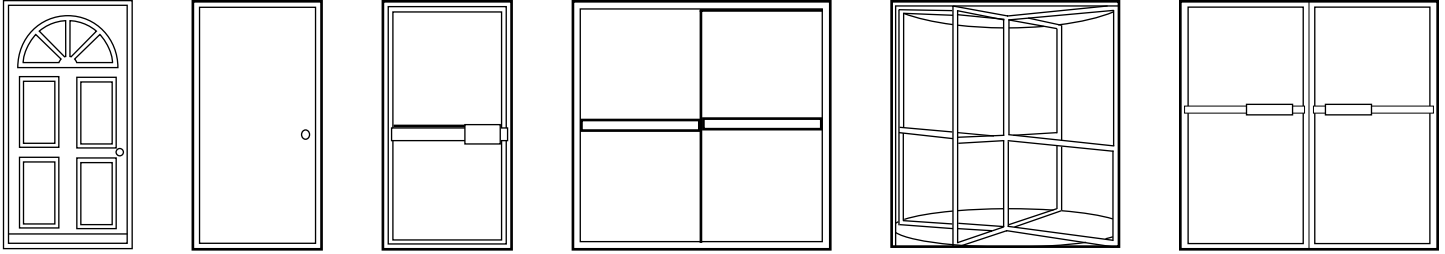

Kits

Most Sealeze weatherseal products are stocked in kits for standard size entrance doors. Kits are available for sweeps, door header and jamb seals, astragal seals and AstraSweep kits which include astragal, sweep and corner seals for a more complete seal around double doors. Kits are pre-cut to size: holders are pre-slotted with self-drilling screws for fast, easy installation. Kits are packaged in clear poly bags with instructions. Easy to stock, easy to use!

Custom Kits

For special door sizes or configurations, Sealeze will custom-cut weatherseal to your specifications and package in clear poly bags.

Bulk*

Weatherseals are also available in bulk to package yourself, or to keep on hand so you can cut to fit as needed.

Cut To Order*

For special door sizes or configurations, Sealeze will custom cut weatherseals to your specifications.

Double Backed Tape

For the fastest installation use our double backed adhesive tape. This makes installation time a matter of seconds and holds securely without screws. It is available in two forms: applied to the weatherseal holder, or in rolls. Weatherseal with applied double backed tape is not slotted.

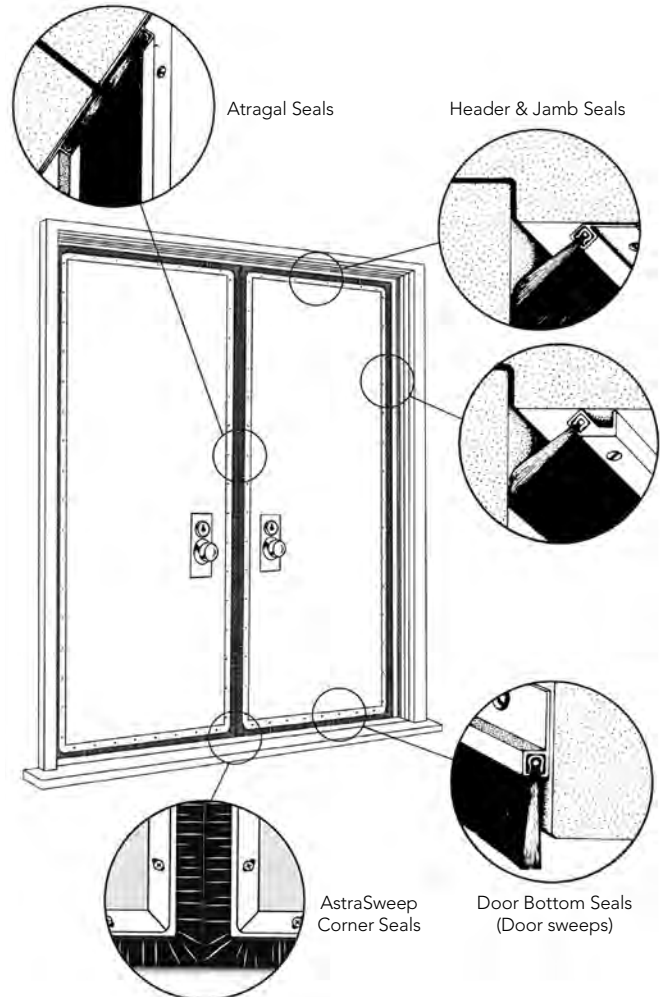

* When ordering please specify: piece length, number of pieces.

Door Sweeps

Brush weatherseals are ideal for sealing the irregular surfaces of thresholds at door bottoms, conforming to the surface while not impairing the door's movements. Select the right brush and holder, based on the size of the gap to be sealed and the desired appearance of the holder.



Sealeze Nylon Therm-L-Brush up to 4 inches long are UL labeled for use on 3-hour fire doors.

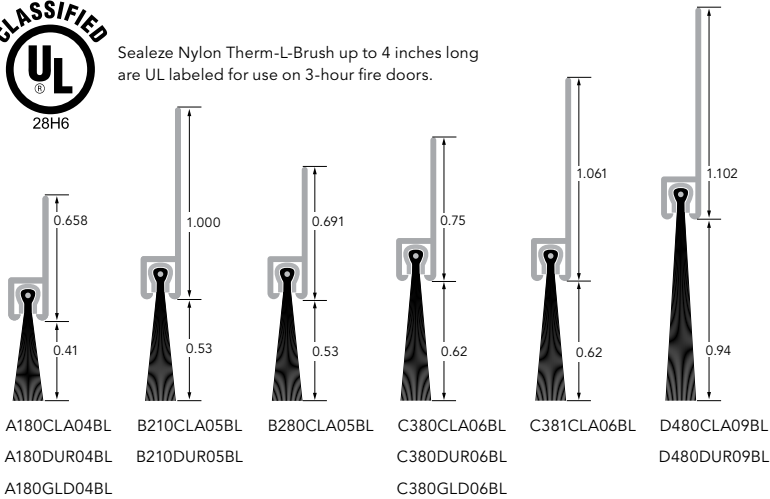

Product Code	Brush Length	Holder Length	Stock Length (feet)
A180CLA04BL	0.41	0.658	7, 8, 10
A180DUR04BL	0.41	0.658	7, 10
A180GLD04BL	0.41	0.658	10
B210CLA05BL	0.53	1.000	3, 7, 10
B210DUR05BL	0.53	1.000	10
B280CLA05BL	0.53	0.691	10
C380CLA06BL	0.62	0.750	3, 7, 10
C380DUR06BL	0.62	0.750	10
C380GLD06BL	0.62	0.750	12
C381CLA06BL	0.62	1.061	8, 10
D480CLA09BL	0.94	1.102	3, 7, 8, 9, 10, 12
D480DUR09BL	0.94	1.102	8, 10, 12

Door Sweep Kits

Aluminum door sweeps in both clear and duranodic finish with black brush are the perfect complement to their corresponding door jamb seals. The aluminum holders are pre-slotted for ease of installation and sweeps are prepackaged with fasteners for 3 ft., 3.5 ft. and 4 ft. doors.

Kit Product Code	Brush Length*	Door Bottom Width (feet)
A180CLA04BL3	0.41	3
A180CLA04BL3.5	0.41	3.5
A180CLA04BL4	0.41	4
A180DUR04BL3	0.41	3
A180DUR04BL3.5	0.41	3.5
A180DUR04BL4	0.41	4
A180GLD04BL3	0.41	3
A180GLD04BL3.5	0.41	3.5
A180GLD04BL4	0.41	4
B210CLA05BL3	0.53	3

Kit Product Code	Brush Length*	Door Bottom Width (feet)
B210CLA05BL3.5	0.53	3.5
B210CLA05BL4	0.53	4
B210DUR05BL3	0.53	3
B210DUR05BL3.5	0.53	3.5
B210DUR05BL4	0.53	4
C380CLA06BL3	0.62	3
C380CLA06BL3.5	0.62	3.5
C380CLA06BL4	0.62	4
C380DUR06BL3	0.62	3
C380DUR06BL3.5	0.62	3.5

Kit Product Code	Brush Length*	Door Bottom Width (feet)
C380DUR06BL4	0.62	4
C380GLD06BL3	0.62	3
C380GLD06BL3.5	0.62	3.5
C380GLD06BL4	0.62	4
D480CLA09BL3	0.94	3
D480CLA09BL3.5	0.94	3.5
D480CLA09BL4	0.94	4
D480DUR09BL3	0.94	3
D480DUR09BL3.5	0.94	3.5
D480DUR09BL4	0.94	4

*All products are available in different brush lengths. Call for assistance with your special application.

How to Select the Right Door Sweep

What size gap are you sealing?	Look at these items:
Up to 3/8"	Starting with the letter "A"
Up to 1/2"	Starting with the letter "B"
Up to 5/8"	Starting with the letter "C"
Up to 1"	Starting with the letter "D"
What color should the holder be?	Look at these items:
Clear Satin (silver in color)	Items with the letters "CLA" in the middle
Bronze (dark brown in color)	Items with the letters "DUR" in the middle
Polished Brass (gold in color)	Items with the letters "GLD" in the middle

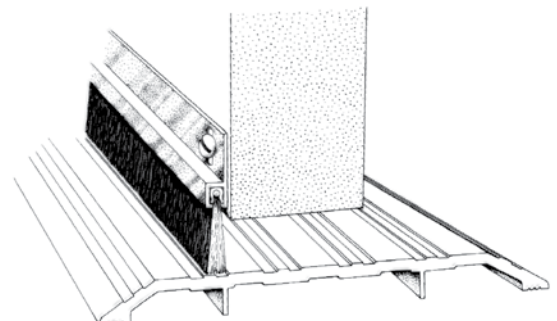

Jamb Seals & Kits

Aluminum door jamb holders are available in clear (silver color), duranodic (brown color) and polished brass (gold color) finishes. These holders are available for doors 3', 4', and 6' wide by 7' high. Kits come with screw slots for after-installation adjustment or with counter-sunk holes for a neat, flush finish. Aluminum door jamb holders are available in clear (silver color), duranodic (brown color) and polished brass (gold color) finishes.



UL listed jamb kits provide reliable seals without restricting automatic door closers. Tested for 2,000,000 cycles by Scovill Laboratories, these high-quality brush seals provide long-lasting, cost-effective service.

Jamb Seals

Product Code	Brush Length	Holder Length	Holder Angle	Finish Color	Stock (feet)
JR40CLA04BL	0.41	0.375	40°	Clear Anodized	7, 8, 9, 10
J135CLA04BL	0.41	0.450	35°	Clear Anodized	7, 10
J135DUR04BL	0.41	0.450	35°	Duranodic	10
J135GLD04BL	0.41	0.450	35°	Gold Anodized	7
J140CLA04BL	0.41	0.750	40°	Clear Anodized	7, 8, 10
J140DUR04BL	0.41	0.750	40°	Duranodic	7, 10

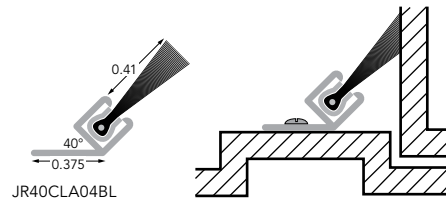

Jamb Seal Kits (Stock Items)

Product Code	Brush Length	Door Size (feet)	Finish Color
JR40CLA04BL17	0.41	3 X 7	Clear Anodized
JR40CLA04BL18	0.41	4 X 7	Clear Anodized
JR40CLA04BL20	0.41	6 X 7	Clear Anodized
J135CLA04BL17	0.41	3 X 7	Clear Anodized
J135CLA04BL18	0.41	4 X 7	Clear Anodized
J135CLA04BL20	0.41	6 X 7	Clear Anodized
J135DUR04BL17	0.41	3 X 7	Duranodic Finish
J135DUR04BL18	0.41	4 X 7	Duranodic Finish
J135DUR04BL20	0.41	6 X 7	Duranodic Finish
J135GLD04BL17	0.41	3 X 7	Gold Anodized
J135GLD04BL18	0.41	4 X 7	Gold Anodized
J135GLD04BL20	0.41	6 X 7	Gold Anodized
J140CLA04BL17	0.41	3 X 7	Clear Anodized
J140CLA04BL18	0.41	4 X 7	Clear Anodized
J140CLA04BL20	0.41	6 X 7	Clear Anodized
J140DUR04BL17	0.41	3 X 7	Duranodic Finish
J140DUR04BL18	0.41	4 X 7	Duranodic Finish
J140DUR04BL20	0.41	6 X 7	Duranodic Finish

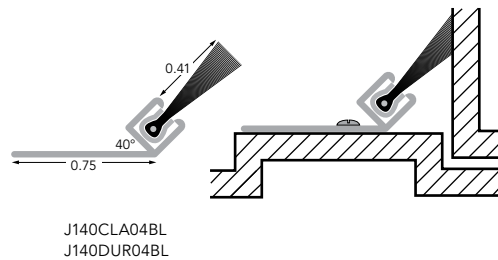
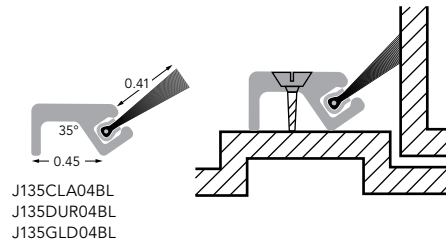

Brush lengths also available in 0.75" and 1.00".

JR40 and J140 kits come with screw slots for after-installation adjustments. J135 kits have counter-sunk screw holes for a neat, flush finish. Fasteners and installation instructions are provided with all kits.

Selecting The Right Door Jamb

What color do you need? Select:

Clear Satin (silver in color)..... Items with letters "CLA" in the middle
 Bronze (dark brown in color) Items with the letters "DUR" in the middle
 Polished Brass (gold in color) ... Items with the letters "GLD" in the middle

What size is the door? Select:

3' x 7' Item with product code ending in 17
 4' x 7' Item with product code ending in 18
 6' x 7' Item with product code ending in 20

What style holder should be used?

It's strictly a matter of preference. Our JR40 extrusion is the smallest, offering a .375" flange at a 40° angle. The J140 extrusion is slightly larger with a .75" flange at a 40° angle while the J135 extrusion brings a more "finished" look to your jambs with a .45" flange at a 35° angle.

Astragal Seals for Wood and Metal Doors

Therm-L-Brush® is perfect for astragal applications when closing the gap between two doors is necessary. Fourteen and sixteen foot standard kits, available in our A180 or C380 product codes, come poly-bagged to include fasteners and installation instructions for wood doors. Metal doors are sealed just as quickly when our weatherseals are applied by using double backed tape.

Astragal Seals

Product Code	Brush Length	Straight Holder Length	Stock Length (feet)
A180CLA04BL	0.41	0.658	7, 8
A180DUR04BL	0.41	0.658	7, 8
A180GLD04BL	0.41	0.658	7, 8
C380CLA06BL	0.62	0.750	7, 8
C380DUR06BL	0.62	0.750	7, 8
C380GLD06BL	0.62	0.750	7, 8

Astragal Kits

Kit Product Code	Brush Length	Door Height (feet)
A180CLA04BL14	0.41	7
A180DUR04BL14	0.41	7
A180GLD04BL14	0.41	7
C380CLA06BL14	0.62	7
C380DUR06BL14	0.62	7
C380GLD06BL14	0.62	7
A180CLA04BL16	0.41	8
A180DUR04BL16	0.41	8
A180GLD04BL16	0.41	8
C380CLA06BL16	0.62	8
C380DUR06BL16	0.62	8
C380GLD06BL16	0.62	8

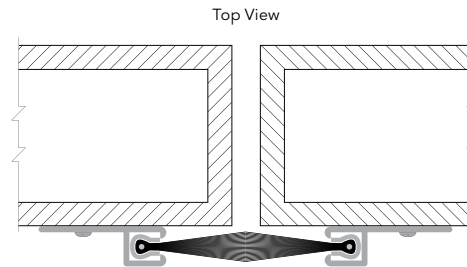

AstraSweep™ Kits

Sealeze AstraSweep corner seals seal the hole between the astragal seal and the door sweep. AstraSweep Kits include two corner seals, two door sweeps and two astragal seals—all the materials necessary to seal the inside (gaps up to 1 inch) and bottoms of a double door. Holders are pre-slotted for easy installation.

Kit Product Code	Door Size (W x H, feet)	Finish Color
C380CLA06BL67	6 x 7	Clear Anodized
C380DUR06BL67	6 x 7	Duranodic
C380CLA06BL68	6 x 8	Clear Anodized
C380DUR06BL68	6 x 8	Duranodic
C380CLA06BL77	7 x 7	Clear Anodized
C380DUR06BL77	7 x 7	Duranodic
C380CLA06BL78	7 x 8	Clear Anodized
C380DUR06BL78	7 x 8	Duranodic
C380CLA06BL87	8 x 7	Clear Anodized
C380DUR06BL87	8 x 7	Duranodic
C380CLA06BL88	8 x 8	Clear Anodized
C380DUR06BL88	8 x 8	Duranodic

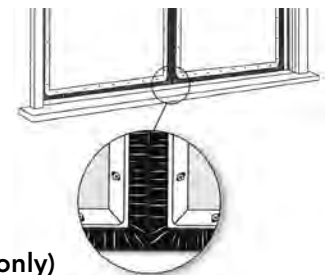

AstraSweep (corner seal only)

(includes 2 seals for size "C" door sweep and astragal seal)

Kit Product Code	Finish Color
C38090CLA06BLKP	Clear Anodized
C38090DUR06BLKP	Duranodic

Brush Weatherseals for Overhead Doors

To minimize air and dirt infiltration around rolling steel, sectional and sliding overhead doors, install the best weatherseals available. Sealeze Brush Weatherseal's unique property of conforming to irregular surfaces provides the most effective sealing. Thousands of filaments form a solid wall for a complete weather-tight seal without impairing door movement. Order with slots & screws, or with easy-to-install double backed tape.

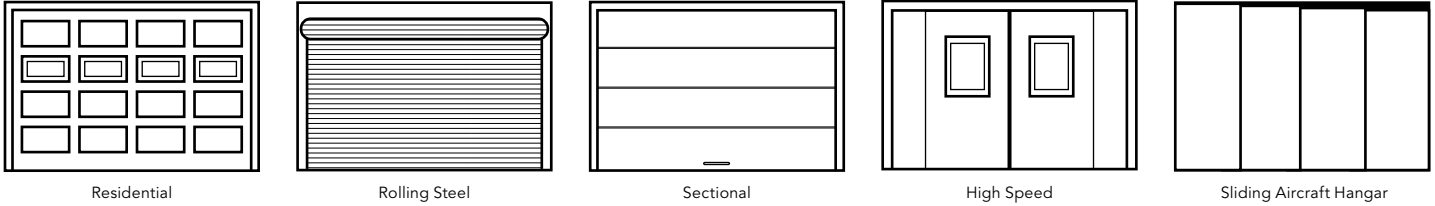

Residential

Rolling Steel

Sectional

High Speed

Sliding Aircraft Hangar

Side view of Header Seal

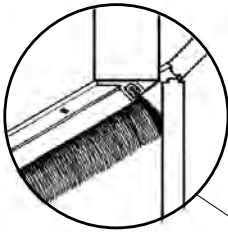

Use angled holder so top of door closes into brush for tight seal.

Side view of Header Seal

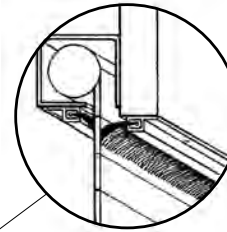

Straight holder mounts on inside of door or mounts to header exterior. Brush outlasts the vinyl flap that comes with most installations and keeps out birds, bats and insects.

Top view of Jamb Seal



Use angled holder on jambs. Brush fills all corrugations for complete seal.

Top view of Jamb Seal

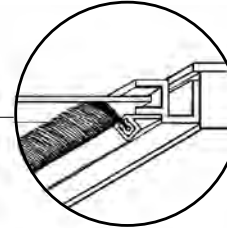

Behind-Wall Installation: Use angled holder on jambs.

Top view of Jamb Seal

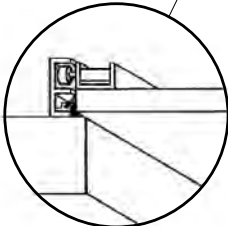

Angled holder can be mounted on inside so brush seals against edge of door. Inside mount hides seal and prevents potential impact damage. Use double backed tape for easiest installation.

Side view of Door Bottom Seal

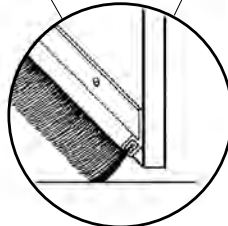

Mount angled holder across door bottom so brush flexes on to pavement to complete all around sealing of door.

Top view of Jamb Seal

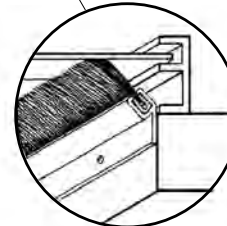

Behind-Wall Installation: Use reverse angled holder on guides.

Keeps out Drafts • Rain • Snow • Wind • Sand • Debris • Light • Noise • Insects • Rodents • Birds • Bats

Light Duty

Light-duty brush seals are ideal for residential and commercial sectional doors. JR40 and J140 are available in kits for 9 X 7 ft. and 16 X 7 ft. garage doors.

Product Code	Brush Length	Holder Length	Holder Angle
JR40CLA08BL	0.75	0.375	40°
JR40CLA10BL	1.00	0.375	40°
J140CLA08BL	0.75	0.750	40°
J140DUR08BL	0.75	0.750	40°
J140CLA10BL	1.00	0.750	40°
J140DUR10BL	1.00	0.750	40°
B230CLA10BL	1.00	0.862	30°
B210CLA10BL	1.00	1.000	180°
B210DUR10BL	1.00	1.000	180°
C380CLA10BL	1.00	0.750	180°
C380DUR10BL	1.00	0.750	180°
C380GLD10BL	1.00	0.750	180°

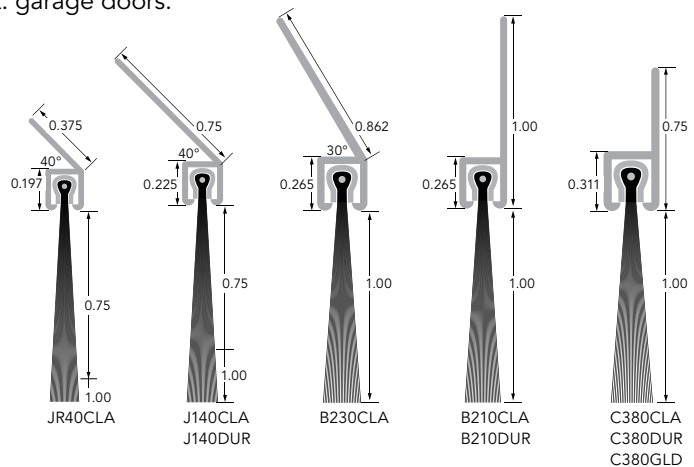

Standard Duty

Standard duty brush seals are the perfect seal for all sectional, rolling steel, and other service doors. Sealeze "D" series is synonymous with quality, energy-saving and value. Available in brush lengths from 1 to 3 inches.

Product Code	Brush Length	Holder Length	Holder Angle
D480CLA09BL	0.94	1.102	180°
D480DUR09BL	0.94	1.102	180°
D480CLA12BL	1.19	1.102	180°
D480DUR12BL	1.19	1.102	180°
D480CLA16BL	1.61	1.102	180°
D480DUR16BL	1.61	1.102	180°
D480CLA20BL	2.00	1.102	180°
D480DUR20BL	2.00	1.102	180°
D480CLA30BL	3.00	1.102	180°
D480DUR30BL	3.00	1.102	180°
D482CLA09BL	0.94	1.891	180°
D482CLA12BL	1.19	1.891	180°
D482CLA16BL	1.61	1.891	180°
D482CLA20BL	2.00	1.891	180°
D482CLA30BL	3.00	1.891	180°
D483CLA09BL	0.94	3.391	180°
D483CLA12BL	1.19	3.391	180°
D483CLA16BL	1.61	3.391	180°
D483CLA20BL	2.00	3.391	180°
D483CLA30BL	3.00	3.391	180°
D445CLA09BL	0.94	0.844	45°
D445DUR09BL	0.94	0.844	45°
D445CLA12BL	1.19	0.844	45°
D445DUR12BL	1.19	0.844	45°
D445CLA16BL	1.61	0.844	45°
D445DUR16BL	1.61	0.844	45°
D445CLA20BL	2.00	0.844	45°
D445DUR20BL	2.00	0.844	45°
D445CLA30BL	3.00	0.844	45°
D445DUR30BL	3.00	0.844	45°
D45XCLA09BL	0.94	1.890	45°
D45XCLA12BL	1.19	1.890	45°
D45XCLA16BL	1.61	1.890	45°
D45XCLA20BL	2.00	1.890	45°
D45XCLA30BL	3.00	1.890	45°
D45RCLA09BL	0.94	1.000	45° REV
D45RCLA12BL	1.19	1.000	45° REV
D45RCLA16BL	1.61	1.000	45° REV
D45RCLA20BL	2.00	1.000	45° REV
D45RCLA30BL	3.00	1.000	45° REV



Sealeze nylon Therm-L-Brush up to 4 inches long are UL labeled for use on 3-hour fire doors.

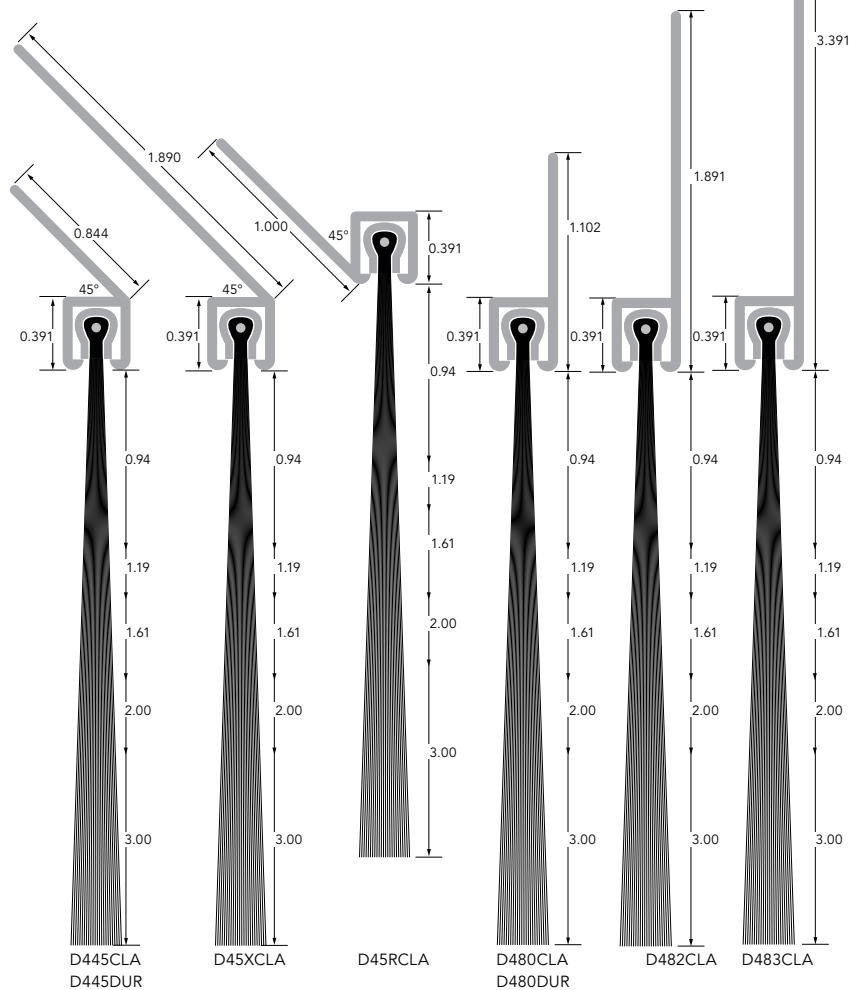

Heavy Duty

The heaviest brush seals available, Sealeze's "G" series brushes seal out the elements around large industrial rolling steel doors, sectional doors, and other large service doors, including aircraft hangar doors. Available in brush lengths up to 7". UL rating on all brushes up to 4" in length.

Product Code	Brush Length	Holder Length	Holder Angle
F580CLA15BL	1.50	1.00	180°
F580CLA20BL	2.00	1.00	180°
F580CLA25BL	2.50	1.00	180°
F580CLA30BL	3.00	1.00	180°
F580CLA40BL	4.00	1.00	180°
F580CLA50BL	5.00	1.00	180°

Product Code	Brush Length	Holder Length	Holder Angle
F582CLA15BL	1.50	1.50	180°
F582CLA20BL	2.00	1.50	180°
F582CLA25BL	2.50	1.50	180°
F582CLA30BL	3.00	1.50	180°
F582CLA40BL	4.00	1.50	180°
F545CLA15BL	1.50	1.50	45°

Product Code	Brush Length	Holder Length	Holder Angle
F545CLA20BL	2.00	1.50	45°
F545CLA25BL	2.50	1.50	45°
F545CLA30BL	3.00	1.50	45°
F545CLA40BL	4.00	1.50	45°
F545CLA50BL	5.00	1.50	45°

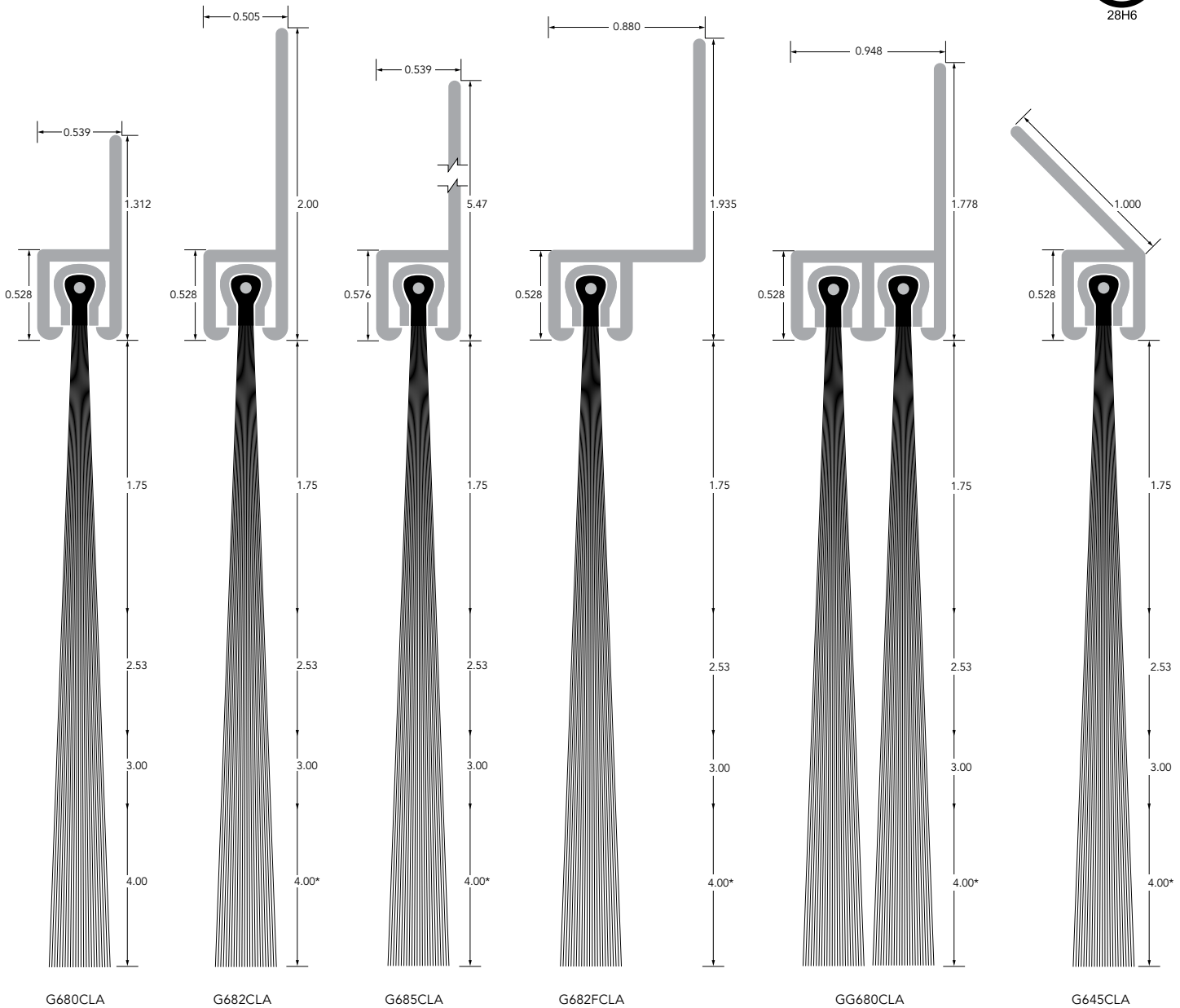

*Brush available up to 7", UL only applies to brush up to 4".

Heavy Duty

Sealeze "F" series brush are a cost-effective solution in many applications where the heavy density of our "G" series brush isn't needed. Available in lengths up to 5 inches, F-series brushes can seal gaps in many large door applications.

Product Code	Brush Length	Holder Length	Holder Angle
F590CLA15BL	1.50	1.47	90°
F590CLA20BL	2.00	1.47	90°
F590CLA25BL	2.50	1.47	90°
F590CLA30BL	3.00	1.47	90°
F590CLA40BL	4.00	1.47	90°
F590CLA50BL	5.00	1.47	90°
G680CLA18BL	1.75	1.312	180°
G680CLA25BL	2.53	1.312	180°
G680CLA30BL	3.00	1.312	180°
G680CLA40BL	4.00	1.312	180°
G680CLA50BL	5.00	1.312	180°
G680CLA60BL	6.00	1.312	180°
G680CLA70BL	7.00	1.312	180°
G682CLA18BL	1.75	2.00	180°
G682CLA25BL	2.53	2.00	180°
G682CLA30BL	3.00	2.00	180°
G682CLA40BL	4.00	2.00	180°
G682CLA50BL	5.00	2.00	180°
G682CLA60BL	6.00	2.00	180°
G682CLA70BL	7.00	2.00	180°
G685CLA18BL	1.75	5.470	180°
G685CLA25BL	2.53	5.470	180°
G685CLA30BL	3.00	5.470	180°
G685CLA40BL	4.00	5.470	180°
G685CLA50BL	5.00	5.470	180°
G685CLA60BL	6.00	5.470	180°
G685CLA70BL	7.00	5.470	180°
G682FCLA18BL	1.75	1.935	180° Offset
G682FCLA25BL	2.53	1.935	180° Offset
G682FCLA30BL	3.00	1.935	180° Offset
G682FCLA40BL	4.00	1.935	180° Offset
G682FCLA50BL	5.00	1.935	180° Offset
G682FCLA60BL	6.00	1.935	180° Offset
G682FCLA70BL	7.00	1.935	180° Offset
GG680CLA18BL	1.75	1.778	180°
GG680CLA25BL	2.53	1.778	180°
GG680CLA30BL	3.00	1.778	180°
GG680CLA40BL	4.00	1.778	180°
GG680CLA50BL	5.00	1.778	180°
GG680CLA60BL	6.00	1.778	180°
GG680CLA70BL	7.00	1.778	180°
G645CLA18BL	1.75	1.000	45°
G645CLA25BL	2.53	1.000	45°
G645CLA30BL	3.00	1.000	45°
G645CLA40BL	4.00	1.000	45°
G645CLA50BL	5.00	1.000	45°
G645CLA60BL	6.00	1.000	45°
G645CLA70BL	7.00	1.000	45°

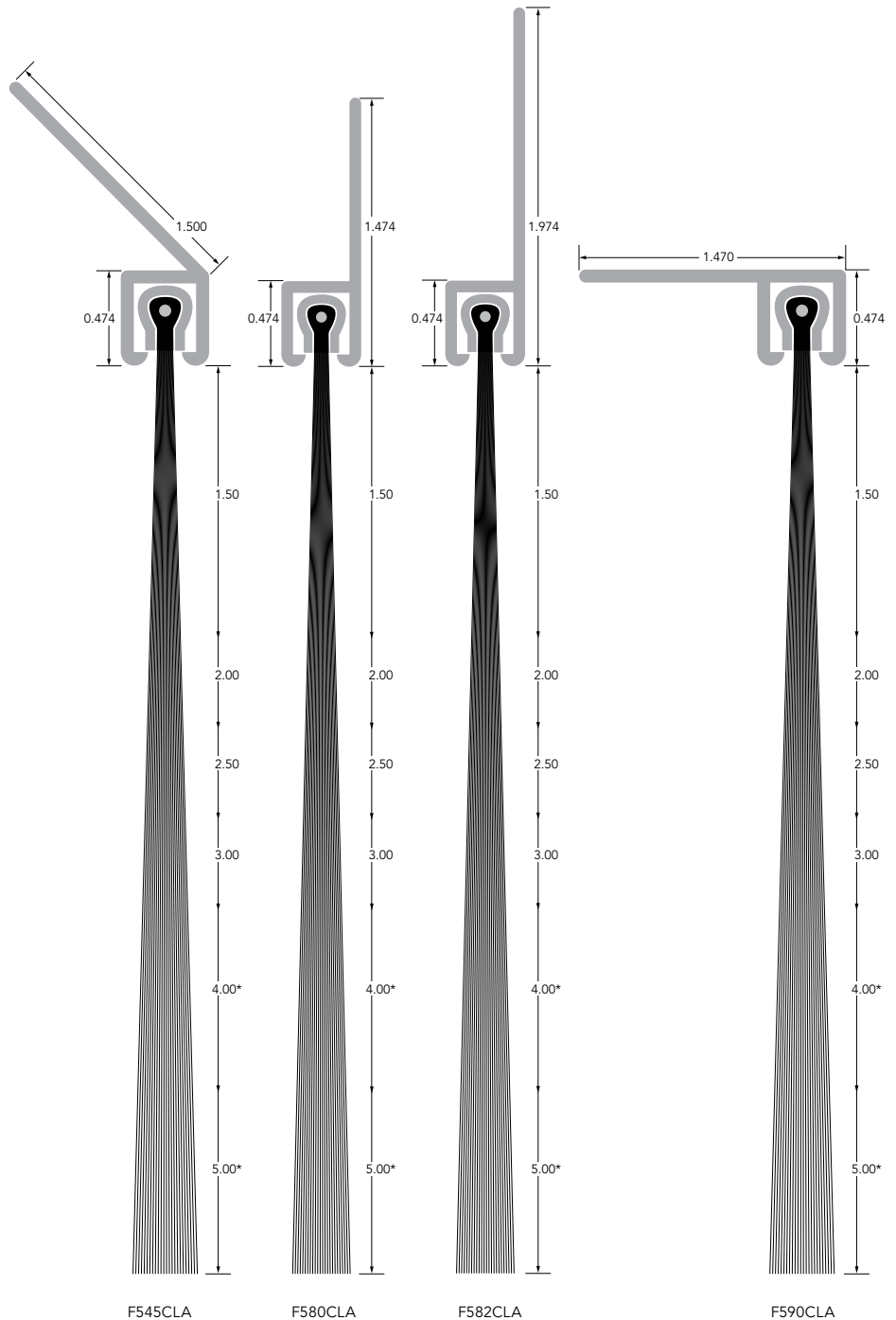

*UL only applies to brush up to 4".

All dimensions in inches, unless otherwise indicated.

Plastic Guide Seal for Rolling Steel Door

Easy installation. Just slide extrusion over guide and let the brush conform to all surface irregularities. Extrusion fits 3/16" guides. Use alone or with epoxy for additional hold.

Product Code	Brush Length	Holder Length	Holder Angle
DP40PVC09BL	0.94	.75	40°
DP40PVC12BL	1.19	.75	40°
DP40PVC16BL	1.61	.75	40°
DP40PVC20BL	2.00	.75	40°
DP40PVC30BL	3.00	.75	40°

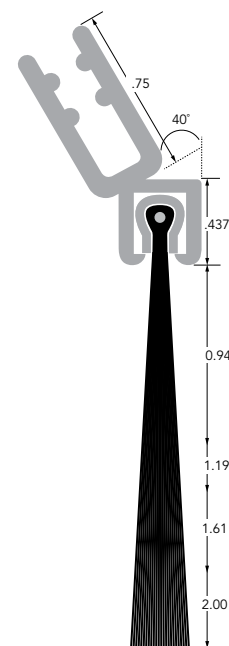

Reverse Angle Clip-On

For use on commercial sectional doors. Dual durometer construction provides a hard vinyl holding section and a flexible flap. Use in situations where price is a key consideration. Fits 1/8 inch guides. Sold in cartons of 200 feet.

Product Code	Color
RG15GRYVNYL	Gray
RG15W HTVNYL	White

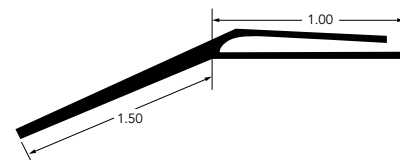

Garage Door Threshold

- Solid black vinyl garage door threshold.
- Seals out the elements.
- Prevents driving rain and snow from backing into garage.
- Helps keep out dirt and leaves.
- Keeps door bottom from direct contact with concrete to prevent rust on metal doors and water damage on wood doors.
- Easy to install: Brush or wipe concrete clean and dry below door. Rough surface with wire brush for best adhesion. Apply adhesive per instructions on tube. One tube comes with every 20 feet of threshold. Installation works best when temperatures are above 50° F.

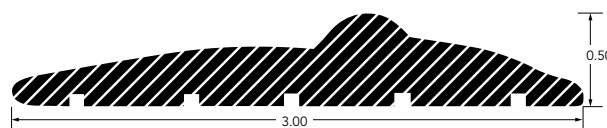

Adjustable Door Bottom

- Black Santoprene rubber.
- Won't tear or deform.
- Remains pliable in the coldest weather.
- Cushions door when closing.
- Two sizes available.
- Aluminum holder comes slotted, allowing for adjustments so it fits perfectly.

Product Code	X	Y	Z
ADB40BLK	1.75	1.00	1.5
ADB25BLK	1.375	1.00	1.0

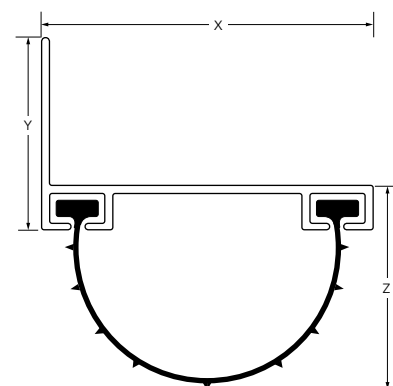

ProSeal

As a low-cost alternative to Therm-L-Brush, we also stock a line of polypropylene brushes. ProSeal brush lengths are from 1 inch to 4 inches and fit nicely into any of our "C" or "D" series holders. See chart below for holder and brush combinations available for ProSeal. Also available is a 1-3/8 inch gray vinyl flap. ProSeal brushes are available in a range of stock lengths, depending on product code.

ProSeal For Mini-Storage Doors

ProSeal size C brush and holders are an excellent choice for sealing corrugated roll-up doors in mini-storage units. It is available with straight exposed polypropylene filament in 1.0, 1.5, 2.0 and 3.0 inches for the best seal in these applications.

ProSeal for Aircraft Hangars/Barns

These crimped polypropylene brushes were developed for special use in sealing Aircraft Hangar Doors. This lower priced brush seals the large gaps usually associated with Hangar Doors while providing most of the advantages of nylon Therm-L-Brush. The brush can be combined with angled or straight holders and is available in brush trim lengths of 1.5, 2, 3, and 4 inches.

ProSeal or Therm-L-Brush, Which is for Me?

The sealing performance of Therm-L-Brush and ProSeal are comparable in most applications. Therm-L-Brush nylon filaments are more suitable for high-cycle applications. In lighter duty applications, the lower cost of ProSeal with polypropylene filaments can be considered.

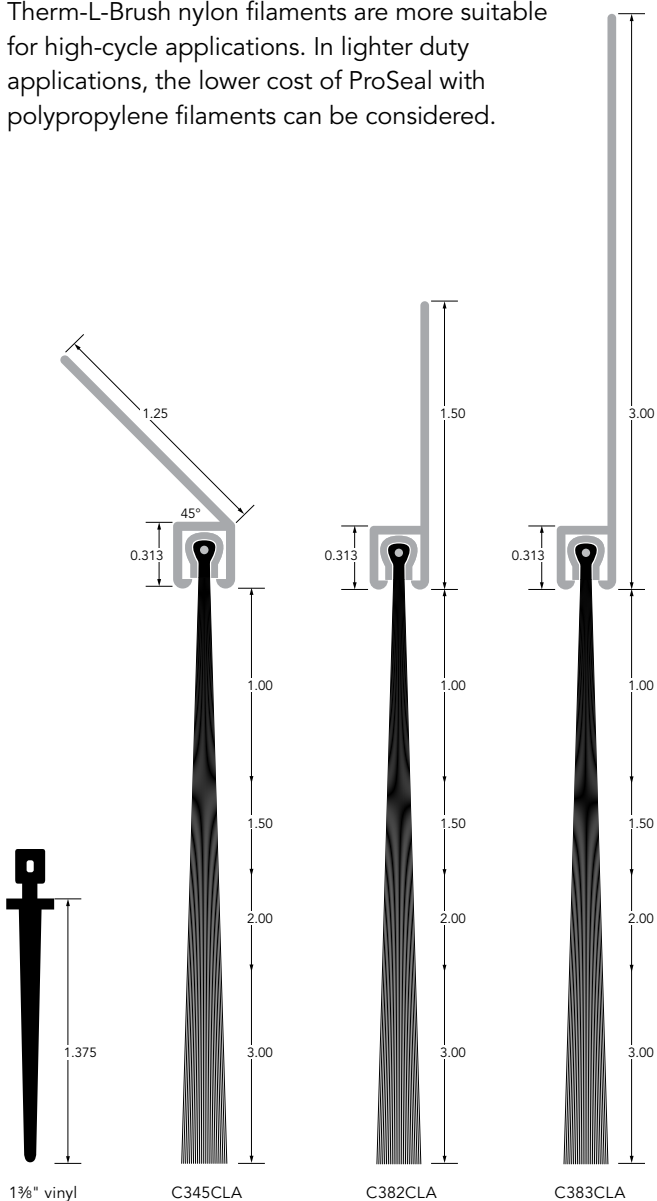

Product Code	Brush Type	Brush Length	Holder Length	Holder Angle
C382CLA10BP	Straight Polypropylene	1.00	1.813	180°
C382CLA15BP	Straight Polypropylene	1.50	1.813	180°
C382CLA20BP	Straight Polypropylene	2.00	1.813	180°
C382CLA30BP	Straight Polypropylene	3.00	1.813	180°
C383CLA10BP	Straight Polypropylene	1.00	3.313	180°
C383CLA15BP	Straight Polypropylene	1.50	3.313	180°
C383CLA20BP	Straight Polypropylene	2.00	3.313	180°
C383CLA30BP	Straight Polypropylene	3.00	3.313	180°
C345CLA10BP	Straight Polypropylene	1.00	1.250	45°
C345CLA15BP	Straight Polypropylene	1.50	1.250	45°
C345CLA20BP	Straight Polypropylene	2.00	1.250	45°
C345CLA30BP	Straight Polypropylene	3.00	1.250	45°
D480CLA15PC	Crimped Polypropylene	1.50	1.102	180°
D480CLA20PC	Crimped Polypropylene	2.00	1.102	180°
D480CLA30PC	Crimped Polypropylene	3.00	1.102	180°
D480CLA40PC	Crimped Polypropylene	4.00	1.102	180°
D482CLA15PC	Crimped Polypropylene	1.50	1.811	180°
D482CLA20PC	Crimped Polypropylene	2.00	1.811	180°
D482CLA30PC	Crimped Polypropylene	3.00	1.811	180°
D482CLA40PC	Crimped Polypropylene	4.00	1.811	180°
D483CLA15PC	Crimped Polypropylene	1.50	3.391	180°
D483CLA20PC	Crimped Polypropylene	2.00	3.391	180°
D483CLA30PC	Crimped Polypropylene	3.00	3.391	180°
D483CLA40PC	Crimped Polypropylene	4.00	3.391	180°
D445CLA15PC	Crimped Polypropylene	1.50	0.844	45°
D445CLA20PC	Crimped Polypropylene	2.00	0.844	45°
D445CLA30PC	Crimped Polypropylene	3.00	0.844	45°
D445CLA40PC	Crimped Polypropylene	4.00	0.844	45°
D45XCLA15PC	Crimped Polypropylene	1.50	1.890	45°
D45XCLA20PC	Crimped Polypropylene	2.00	1.890	45°
D45XCLA30PC	Crimped Polypropylene	3.00	1.890	45°
D45XCLA40PC	Crimped Polypropylene	4.00	1.890	45°
D45RCLA15PC	Crimped Polypropylene	1.50	1.000	45 REV°
D45RCLA20PC	Crimped Polypropylene	2.00	1.000	45 REV°
D45RCLA30PC	Crimped Polypropylene	3.00	1.000	45 REV°
D45RCLA40PC	Crimped Polypropylene	4.00	1.000	45 REV°
D490CLA15PC	Crimped Polypropylene	1.50	1.060	90°
D490CLA20PC	Crimped Polypropylene	2.00	1.060	90°
D490CLA30PC	Crimped Polypropylene	3.00	1.060	90°
D490CLA40PC	Crimped Polypropylene	4.00	1.060	90°

Specify 1", 1.50", 2", 3" brush or 1.375" vinyl.

All dimensions in inches, unless otherwise indicated.

Dock Leveler Applications

Loading docks are prime areas for sealing with brush weatherseal. Not only do the overhead doors allow air infiltration, but the dock levelers themselves can act as wind tunnels, robbing a building of its conditioned air supply. Sealeze's 90° flanges form the perfect fit for dock leveler seals and other special applications. Our "A" series is ideal for sealing small cracks, while the "G" series brush will cover the largest gaps.

Dock Leveler Seals

Product Code	Brush Length	Holder Length	Holder Angle
A190CLA04BL	0.41	0.55	90°
A190CLA10BL	1.00	0.55	90°
B290CLA05BL	0.53	0.69	90°
B290CLA10BL	1.00	0.69	90°
C390CLA06BL	0.62	0.96	90°
C390CLA10BL	1.00	0.96	90°
D490CLA09BL	0.94	1.06	90°
D490CLA12BL	1.19	1.06	90°

Product Code	Brush Length	Holder Length	Holder Angle
D490CLA16BL	1.61	1.06	90°
D490CLA20BL	2.00	1.06	90°
D490CLA30BL	3.00	1.06	90°
G690CLA18BL	1.75	1.38	90°
G690CLA25BL	2.53	1.38	90°
G690CLA30BL	3.00	1.38	90°
G690CLA40BL	4.00	1.38	90°

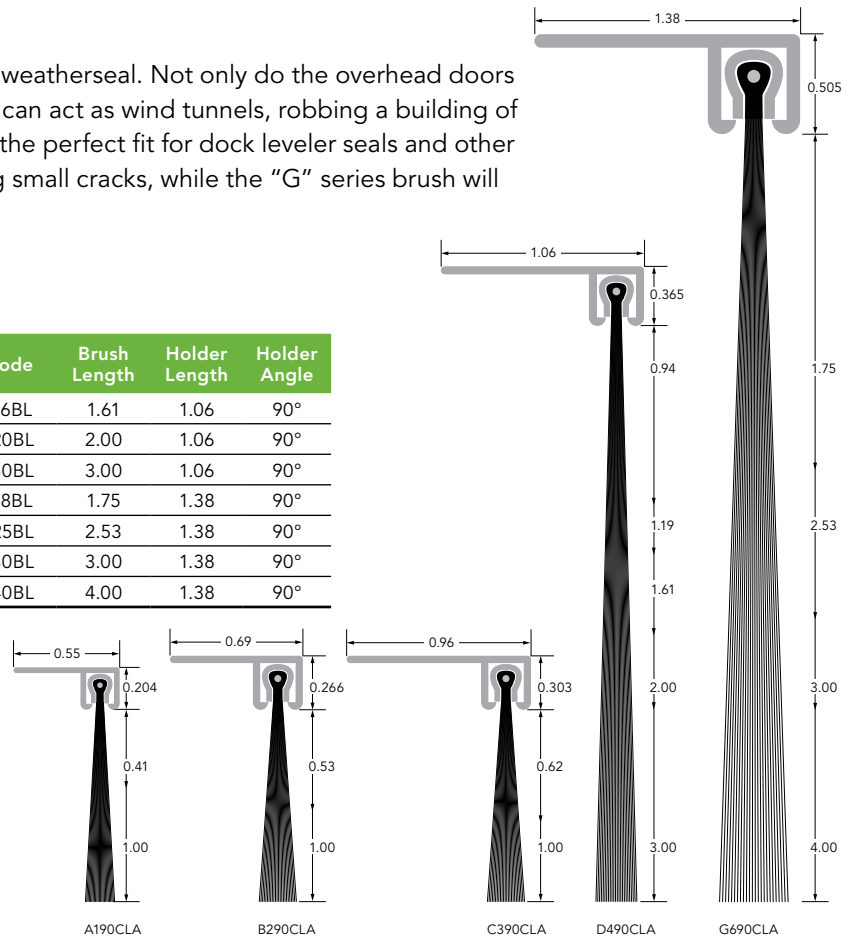

Weldable Dock Leveler Seals

Includes a steel holder that can be welded to the sides of the leveler.

Product Code	Holder Shape	Exposed Seal Length	Seal Type
BT90CLA05BLKIT8	T	0.500	Brush
BT90CLA10BLKIT8	T	1.000	Brush
BT90CLA14BLKIT8	T	1.375	Brush
BT90CS15PVCKIT8	T	1.375	PVC
BDL90CS05BLKIT8	L	0.500	Brush
BDL90CS10BLKIT8	L	1.000	Brush
BDL90CS14BLKIT8	L	1.375	Brush
DDL90CS09BLKIT8	L	1.000	Brush
DDL90CS12BLKIT8	L	1.200	Brush
DDL90CS16BLKIT8	L	1.600	Brush
DDL90CS20BLKIT8	L	2.000	Brush
DDL90CS30BLKIT8	L	3.000	Brush

Kits includes two 96 sections. (± .031 standard tolerance)

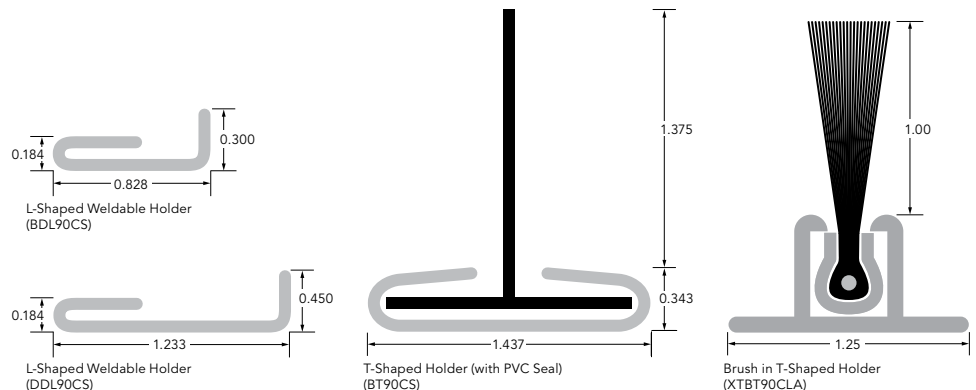

Hinge Seals

For the rear hinge of dock levelers. Choose from a 1" diameter neoprene "rope" seal or 2" x 3" foam stock. Call for details.

Product Code	Description	Dimensions
HINGE-SEAL	Foam Seal	2" x 3" x 7'
HINGE-SEAL-ROD	Hinge Seal Stabilizer	3/8" x 7'
RS1ONEOPR	1" diameter Rope Seal	Cut-To-Order



Flexible Strip **Brush**

Designed to meet the needs of diverse applications, EzFlex® flexible strip brush is flexible enough to fit around tight curves, lighter than typical strip brushes, and easy to use.

EzFlex flexible brush is a cost-effective, light-weight alternative to traditional strip brush for these applications and more...

- eliminate air flow
- light/sound containment
- weatherseal
- pest management

Sealeze EzFlex flexible brush is designed using recyclable nylon filament. The filaments are heat fused to the nylon holder which also clamps around the brush providing a strong bond. Our flex brush, manufactured to fit our standard holders, is an excellent choice for closing gaps, containing air or light and for use on surfaces that are uneven or curved.

EzFlex flexible brush is available in channel or section sizes C, and D, in nearly any length to suit your needs. It's easy to work with and doesn't require special tools. It can be used with our stock aluminum holders. It's stocked in 100 ft. rolls, minimum order is 100 ft.



Installation Instructions for Sealeze Metal-Backed Brush and Aluminum Holders

Therm-L-Brush installs in 5 easy steps to help reduce labor costs and callbacks:

1. Measure the door (bottom, jambs and header).
2. Cut the brush and holder to length.
3. Pry open the ends of the holder with a screwdriver.
4. Insert the brush into the holder and peen both ends of the holder with a hammer to lock the brush in place.
5. Mount the seal by holding the aluminum flange to the jambs or door bottom while aligning brush to the proper fit. Then secure with self-drilling screws provided. Slotted holes allow for easy final adjustment for the perfect fit.

Tips:

- Cut Brush with diagonal cutting pliers, shears or bolt cutters. Cutting action must pinch ends closed to seal in filaments.
- Cut Holder with hack saw, power saw (with metal cutting blade), or angle iron shear.
- Mount Jamb Seals for either entrance or overhead doors by installing header first, then measure for jamb seal.
- Mount so brush is flexed slightly against the door to ensure complete seal and to compensate for wind deflection.
- Mount Sweep so brush just touches floor or top of threshold.
- Mount Astragal Seals so brushes just touch in the center of gap between doors.
- Piece the Brush when door dimensions exceed stocked weatherseal lengths. "Splice" 2 or more pieces together by staggering the brush and holder joints.

Key Terms & Conditions of Sale

Payment: Net Cash 30 days, subject to credit approval

Returns: An RGA number must be issued by Sealeze PRIOR to returning items. Returned goods are subject to a 25% restocking fee. *Only stock items may be returned.*

Minimum Order: \$50.00 net — Stock Items

Prices: Subject to change without notice. Additional discounts are available for quantity purchases. Please ask your Sales Representatives for details.

Complete terms and conditions available upon request and are provided at time of order.